

July 22



Acousto-Optic Modulator Driver

Including: Modulator Alignment

M600 / D600 Series

D1378 series

Instruction Manual, RFA240-2 / RFA250-2 Series RFA440-2 / RFA450-2 Series Analog and Digital Modulation

Models -

<u>Frequency</u>	<u>Peak power</u>	
	160W	220W
40MHz	RFA240-2-x	RFA440-2-x
50MHz	RFA250-2-x	RFA450-2-x

Options **-x**, combinations possible:

- L : active low RF gate (enable)
- D : digital modulation and gate
- V : 0-5V analog modulation range

- BR : Brass water cooled heatsink

ISOMET CORP, 10342 Battleview Parkway, Manassas, VA 20109, USA.

Tel: (703) 321 8301, Fax: (703) 321 8546, e-mail: isomet@isomet.com

www.ISOMET.com

ISOMET (UK) Ltd, 18 Llantarnam Park, Cwmbran, Torfaen, NP44 3AX, UK.

Tel: +44 1633-872721, Fax: +44 1633 874678, e-mail: isomet@isomet.co.uk



1. GENERAL

The RFA2x0-2 and RFA4x0-2 series are combined fixed frequency driver and power amplifier modules specifically designed to operate with the large aperture Germanium acousto-optic modulators. The driver accepts independent modulating and gate inputs and provides a double-sideband amplitude modulated RF output to the acousto-optic modulator. A summary of the driver specification is shown in the following table:

<u>Model</u>	<u>Use with</u>	<u>Center Frequency</u>	<u>Total Output Power</u>
RFA240-2	M600-G40L-series	40MHz	> 160.0 Watt
RFA250-2	M600-G50L-series	50MHz	> 160.0 Watt
RFA440-2	D1378-G40L-12	40MHz	> 220.0 Watt
RFA450-2	D1378-G50L-12	50MHz	> 220.0 Watt

Figure 4 is a block diagram of the driver. The center frequency is determined by a free-running quartz-crystal oscillator. The frequency is accurate to within ± 25 ppm and the stability is better than ± 25 ppm. The oscillator is not temperature stabilized.

A high-frequency, diode ring modulator is used to amplitude-modulate the RF carrier. A common single turn potentiometer provides gain control for adjusting the maximum RF power for both outputs of the driver.

The amplitude-modulated RF is divided and applied to two power amplifier stages.

MMIC RF pre-amplifiers isolate this low-level modulation circuitry from the power amplifier stages.

The two power amplifier stages function in parallel and are designed to operate at full rated power into a 50Ω load with 100% duty cycle.

There are two control inputs: Gate and Modulation. The modulation input is configured at the factory to be either analog (para. 2.2) or digital (-D) option (para. 2.3).

The rise and fall times for the amplifier from either modulation or gate inputs is identical. (approx' 200nsec).

The maximum RF output is set by the power adjust potentiometer 'PWR ADJ2'



NOTE : Maximum RF power = fully clockwise

The analog input level must not exceed 15 volts

The digital input levels must not exceed 7 volts

Water cooling is mandatory. The heatsink temperature must not exceed 70°C.

Corrosion inhibitor should be added to the cooling water

**SERIOUS DAMAGE TO THE AMPLIFIER MAY RESULT IF THE TEMPERATURE EXCEEDS 70°C.
SERIOUS DAMAGE TO THE AMPLIFIER MAY ALSO RESULT IF THE RF OUTPUT CONNECTOR
IS OPERATED OPEN-CIRCUITED OR SHORT-CIRCUITED.**

DC supply

A low impedance DC power supply is required. The operating voltage is +24V or +28Vdc at a current drain of approximately 15A. Please refer to the driver data sheet. The external power source should be regulated to $\pm 2\%$ and the power supply ripple voltage should be less than 200mV for best results. Higher RF output power is achieved at 28Vdc.

2 Control Signals

2.1: Gate input. Disables the RF Output. Default condition is RF On. 5V logic

A TTL equivalent high level will gate the RF **OFF**.

If not connected or driven low (< 0.8V), the RF will be gated **ON**.

The response time of the Gate input is in the millisecond regime.

RF amplitude control is a combination of the modulation **and** gate inputs as illustrated in Figure 2 below for analog modulation drivers.

2.2: Applies to all drivers except option -D

Analog modulation. This configuration gives variable amplitude control of the RF power. An input swing of 10 volt (positive with respect to ground) will result in 100% depth of modulation. An input voltage of less than 0.4V will drive the RF Off. The input level of 10V will result in maximum RF output as pre-set by the RF power adjustment potentiometer.

Typical analog modulation RF waveforms are shown above.

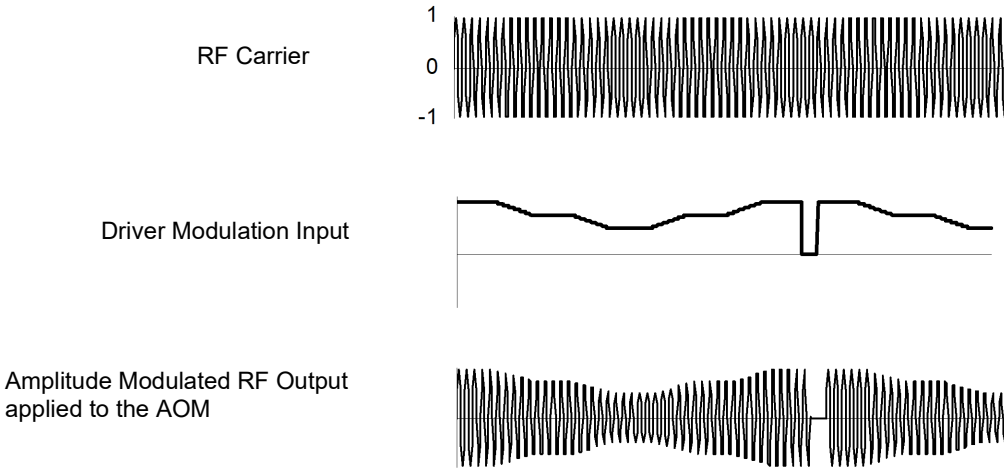

2.3: Applies to drivers with -D option.

Digital modulation. This configuration gives bi-level On:Off amplitude control of the RF power. A TTL high level will turn the RF **ON** and will result in maximum RF output as pre-set by the RF power adjustment potentiometer.

The equivalent waveforms for digital modulation are shown below

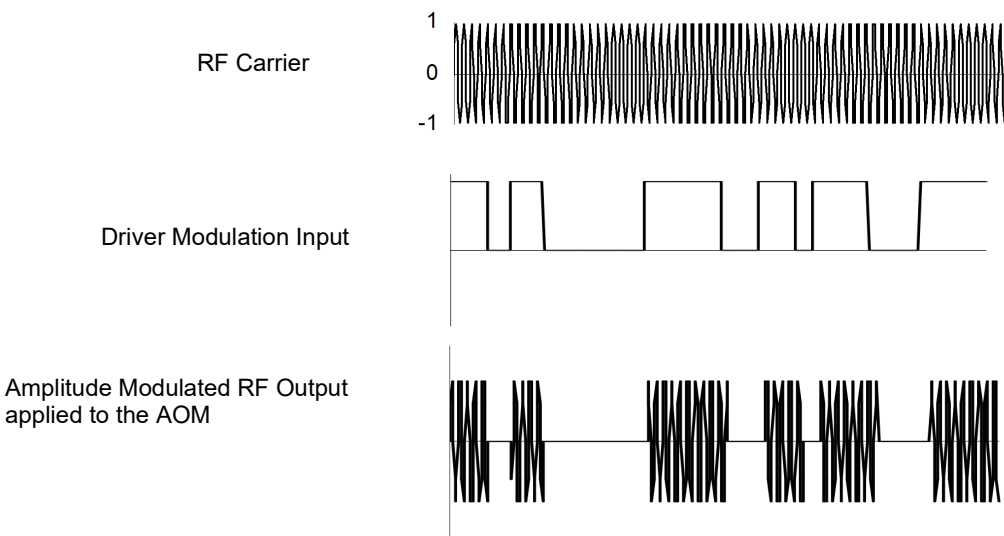

Basic AO calculations are given in Figure 7

AO MODULATION OVERVIEW

To intensity modulate a laser beam in an acousto-optic modulator requires that the input RF carrier voltage (power) be varied according to the video or baseband information. From the viewpoint of intensity modulation, the deflection efficiency equation is normalized as:

$$i_1 = \text{Sin}^2 (kE_{RF})$$

where i_1 is the instantaneous intensity in the first order diffracted beam and E_{RF} is the instantaneous RF envelop voltage across the matched transducer.

In effect, the acousto-optic interaction demodulates the RF carrier, transforming the modulation envelop (baseband signal) into intensity variation of the first order diffracted laser beam.

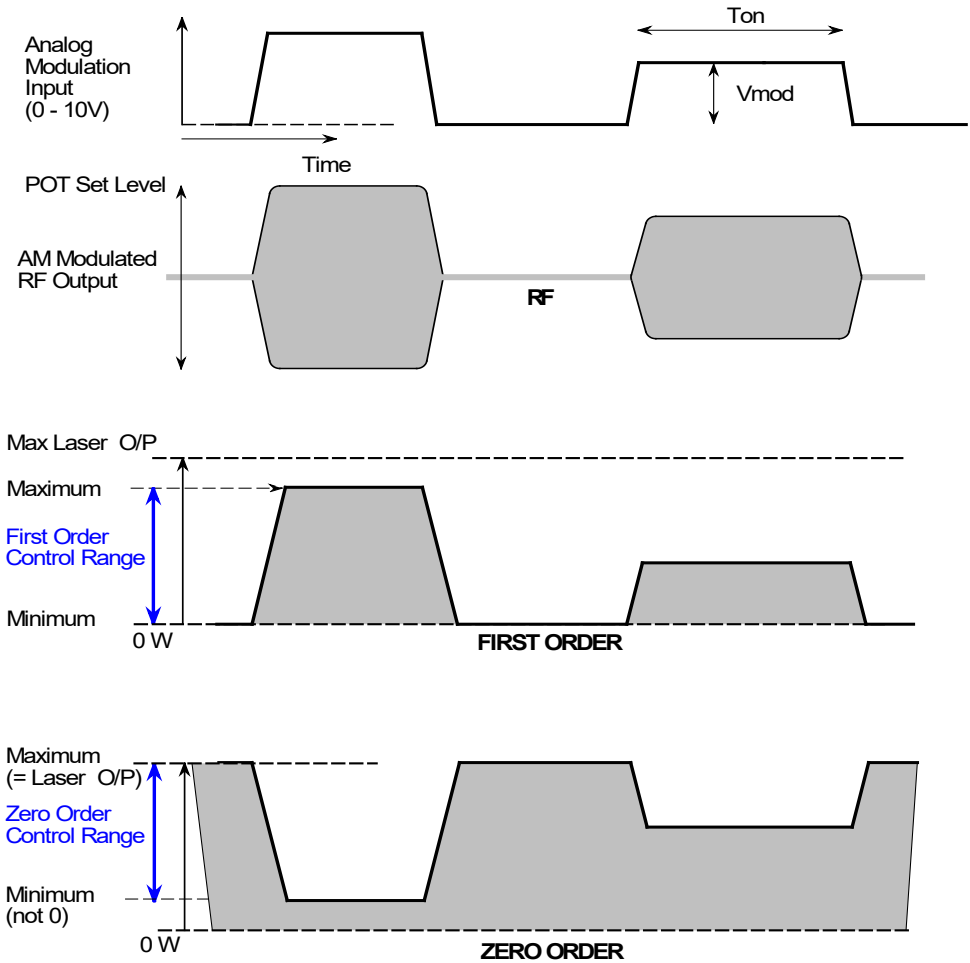
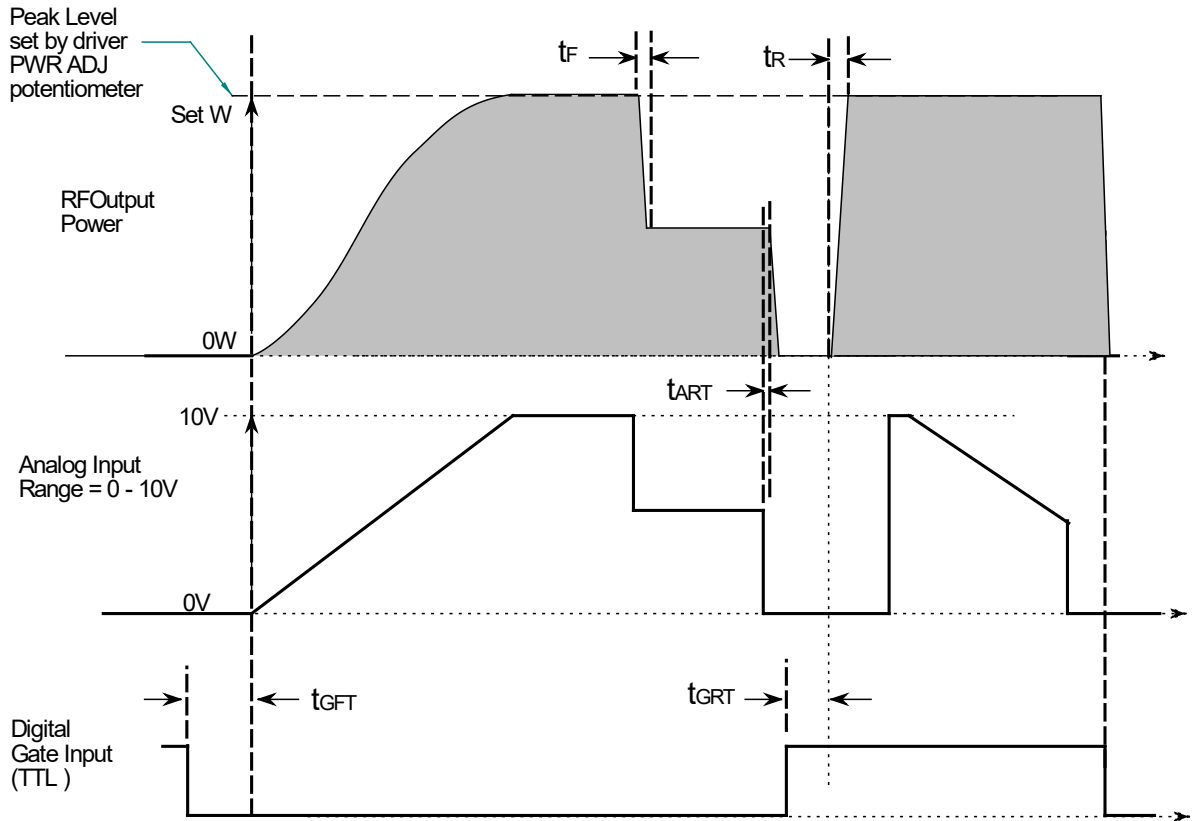

Figure 1: Typical Analog Modulation Waveforms



Description	Variant		
	Standard	-A	-D
t_R RF rise time resulting from large signal modulation.	<250 ns	<250 ns	<250 ns
t_F RF fall time resulting from large signal modulation.	<100 ns	<100 ns	<100 ns
t_{ART} Latency delay between a change in modulation level (A-Mod or D-mod) and RF output.	60 ns	60 ns	60 ns
t_{GRT} Latency delay between a Gate High input and RF output fully disabled.	>1msec	NA	NA
t_{GFT} Latency delay between a Gate Low input and RF output fully enabled.	>1msec	NA	NA

Figure 2: RF output control

2.4 LED INDICATOR

The front panel LED indicator serves to indicate a number of possible operating states.

The LED will illuminate RED or GREEN when the DC power is applied and the Interlocks are valid.

The RF outputs may be “live” if the LED is illuminated RED or GREEN. The colour will depend on the average RF output level.

- Shows GREEN when the RF outputs are live and provided that :
 - a) the modulation duty cycle is more than 20% (approx).
 - b) the RF CW power is > 20% (approx) of the driver maximum power

- Shows RED when one or both RF outputs have low average power
 - e.g. a) Modulation OFF
 - b) RF power set to less than approximately 20% of the maximum driver RF power
 - c) Modulation duty cycle is less than approximately 20%

LED Off

The LED will not illuminate if:

- a) the internal driver thermal interlock switch is open (Over temperature fault)
- b) the AOM thermal interlocks switch is open (Over temperature fault)
- c) the AOM thermal interlock is not connected to the driver interlock input
- d) the DC supply is off.

Standard over-temperature trip points

- RF driver: 50deg C
- AO device: 32deg C (Germanium) or 40degC (Quartz, Fused Silica).

The thermal interlocks will reset once the AO device and / or RF driver are cooled below the trip temperature. The hysteresis of the thermal switches is 7-10deg C. Once in a fault state, the coolant temperature may need to be reduced below the normal operating point to reset the thermal switches.

See AN1710 Resetting the AO Thermal Interlock (<https://isomet.com/appnotes.html>)



3. INSTALLATION AND ADJUSTMENT

Connect cooling water to the RFAxx0-2. Minimum flow rate of 1 litre/minute at < 25 deg.C.
For optimum AO performance ensure the flow rate is more than 2 litres/minute at < 20 deg.C

Refer to Figures 3,4,5. Use of a Corrosion inhibitor is strongly advised.

Connect cooling water to the AO device.

Due to the high RF power dissipated in the AO modulator, it is paramount that the device is operated only when water cooling is circulating.

3.2 With power off, connect the + 24V (or +28V) DC to the feed-thru screw terminals. DO NOT APPLY POWER.

3.1 Connect the BNC output RF1 to the acousto-optic modulator input J1 (or a high power 50Ω RF load, if it is desired to measure the RF1 output power).

Connect the BNC output RF2 to the acousto-optic modulator input J2

Connection order is not critical for modulator applications.

3.4 Connect the Interlock of the acousto-optic modulator (Binder 719 3-pin snap connector) to the enable inputs on the 15-pin D-type connector of the RFAxx0-2. Connect pin 1 of 15wD-type to the pin 2 and pin 9 of 15wD-type to the pin 1. (See Figure 3)

If the temperature of the modulator exceeds 32°C or the internal driver temperature exceeds 50°C then the interlock connection becomes open circuit, disabling the RF output. An LED indicator illuminates when the Interlocks are closed and the RF is enabled. In addition, an open drain 'interlock valid' signal output is provided on pin 2 of the D-type connector for remote monitoring purposes.

3.5 Adjustment of the RF output power is best done with amplifier connected to the acousto-optic modulator. The amplifier maximum output power is factory preset to approx' 50W per output (100W total). Please check test data sheet provided with the unit.

The optimum RF power level required for the modulator to produce maximum first order intensity will be different at various laser wavelengths. Applying RF power in excess of this optimum level will cause a decrease in first order intensity (a false indication of insufficient RF power) and make accurate Bragg alignment difficult. It is therefore recommended that initial alignment be performed at a low RF power level.

- 3.6 Locate the PWR ADJ 2 access hole on the driver end plate.
- 3.7 If uncertain of the power adjust setting then rotate the PWR ADJ potentiometer fully anti-clockwise (CCW) = OFF, then rotate clockwise (CW) approximately 1/3 turn.
- 3.8 For analog modulation drivers e.g. RFAxx0-2 apply a 10.0V constant modulation signal to the modulation inputs on the D-type connector. Connect pin 7 of 'D' to the signal and pin 14 of 'D' to the signal return.

or

- 3.9 For digital modulation drivers e.g. RFAxx0-2D apply a constant TTL **high** modulation signal to the modulation inputs on the D-type connector. Connect pin 7 of 'D' to the signal and pin 14 of 'D' to the signal return.
- 3.10 If the GATE input is to be used, apply a constant TTL **low** level (< 0.8V) to the digital Gate input on the D-type connector. Connect pin 8 of the 'D' to the signal and pin 15 of the 'D' to the signal return. Alternatively, if the RF Gate control is not required, leave unconnected (except option "L" drivers).
- 3.11 Apply DC to the amplifier.

Input the laser beam toward the centre of either aperture of the AOM. Ensure the polarization is horizontal with respect to the base and the beam height does not exceed the active aperture height of the AOM. Start with the laser beam normal to the input optical face of the AOM and very slowly rotate the AOM (either direction). Refer to Figure 6, and appendix-A for beam alignment..

- 3.12 Observe the diffracted first-order output from the acousto-optic modulator and the undeflected zeroth order beam. Adjust the Bragg angle (rotate the modulator) to maximise first order beam intensity.

3.13 **After** the Bragg angle has been optimized, slowly increase the RF power by turning PWR ADJ2 clockwise until maximum first order intensity is obtained.

3.14 The modulator and driver are now ready for use. Figures 1 and 2 illustrate typical modulation characteristics.

4. MAINTENANCE

4.1 Cleaning

It is of utmost importance that the optical apertures of the deflector optical head be kept clean and free of contamination. When the device is not in use, the apertures may be protected by a covering of masking tape. When in use, frequently clean the apertures with a pressurized jet of filtered, dry air.

It will probably be necessary in time to wipe the coated window surfaces of atmospherically deposited films. Although the coatings are hard and durable, care must be taken to avoid gouging of the surface and leaving residues. It is suggested that the coatings be wiped with a soft ball of brushed (short fibres removed) cotton, slightly moistened with clean alcohol. Before the alcohol has had time to dry on the surface, wipe again with dry cotton in a smooth, continuous stroke. Examine the surface for residue and, if necessary, repeat the cleaning.

4.2 Troubleshooting

No troubleshooting procedures are proposed other than a check of alignment and operating procedure. If difficulties arise, take note of the symptoms and contact the manufacturer.

4.3 Repairs

In the event of deflector malfunction, discontinue operation and immediately contact the manufacturer or his representative. Due to the high sensitive of tuning procedures and the possible damage which may result, no user repairs are allowed. Evidence that an attempt has been made to open the optical head will void the manufacturer's warranty.

Connection Summary: 15 way 'D' Type Control

<u>Signal</u> (see notes)	<u>Type</u>	<u>Pin out connection</u>
<p>GATE Digital Gate ** TTL high (2.7v<V<6.0v) = OFF TTL low (0.0v<V<0.8v) or nc = ON [Input current 4.8mA at 5V]</p>	Input	Signal pin 8 Return pin 15
MODULATION		
Analogue Version e.g. RFA240-2 or RFA450-2		
Modulation, proportional* < 0.4V(off) to 10.0V(on) [Input current 4.0mA at 10V]	Input	Signal pin 7 Return pin 14
or -D option		
Digital Version e.g. RFA240-2D or RFA450-2D		
Modulation, ON/OFF * TTL high (2.7v<V<6.0v) = ON TTL low (0.0v<V<0.8v) = OFF [Input current 1.5mA at 5V]	Input	Signal pin 7 Return pin 14
INTERLOCK		
Interlock (NC contact) *** Connect to AO modulator 'INT' [Sink current 10mA]	Input	Signal pin 1 Return pin 9
'Interlock Valid' monitor Open Drain 5V logic, Low = OK Maximum applied voltage = 5.5V via external pull up resistor [Maximum current = 10mA]	Output	Signal pin 2 Return pin 10

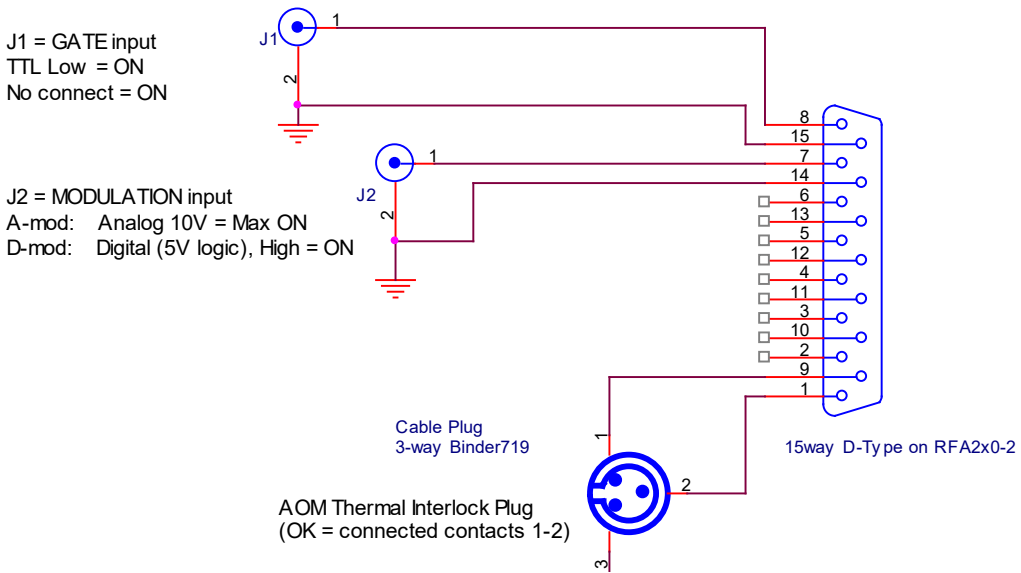

Figure 3: Connections

Notes:

* The modulation input signal (pin 7) needs to be applied.

This is always required even if the digital Gate signal (pin 8) only is used to enable the RF power.

** Except Option “-L” drivers (e.g. RFAxx0-2L) with Inverted Digital Gate

“-L” Digital Gate: TTL Low ($0.0v < V < 0.8v$) = ON
 TTL High or unconnected = OFF

*** The interlock signal must be connected. Contacts closed for normal operation.

Mounting Holes: 4 off x M5

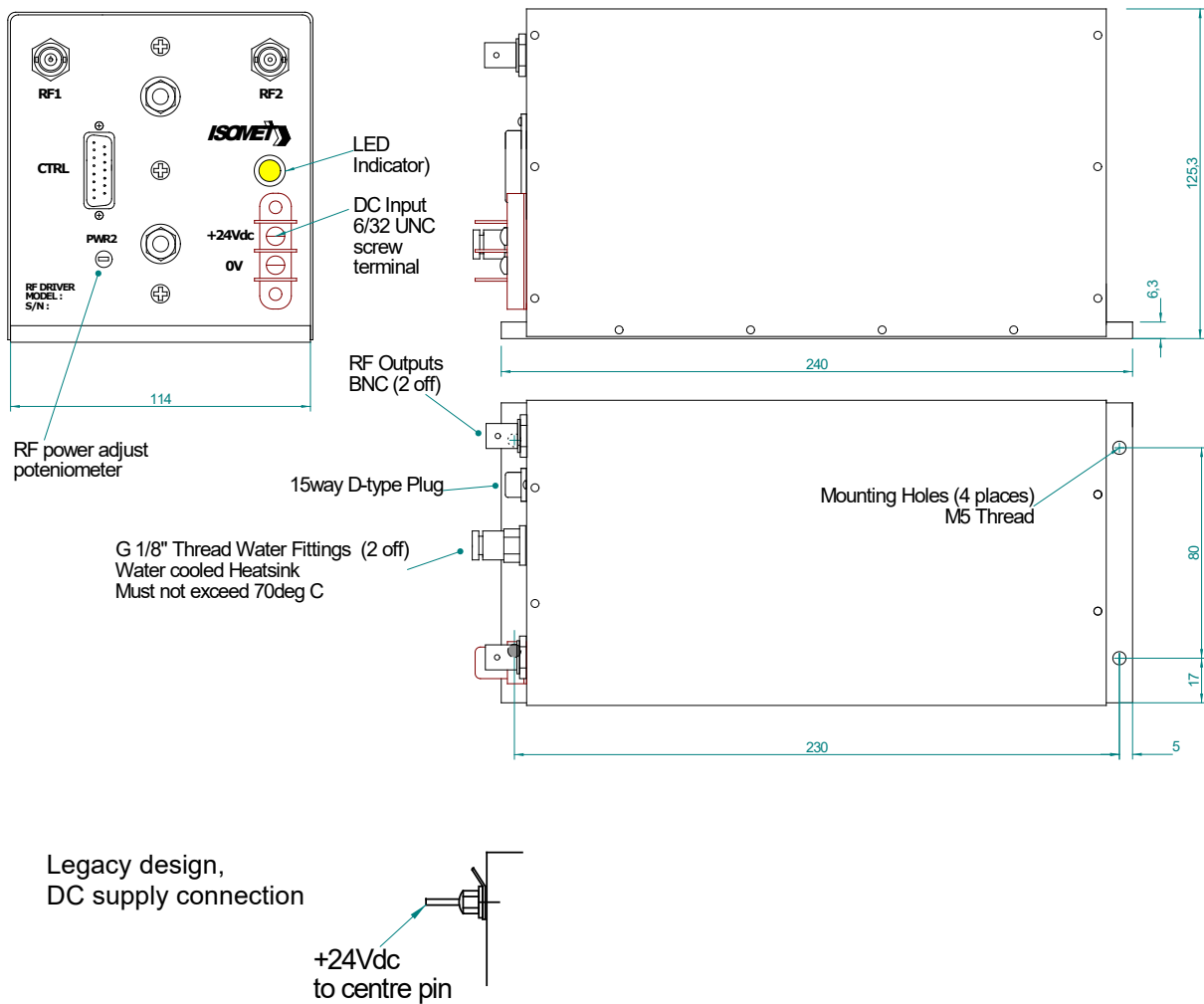
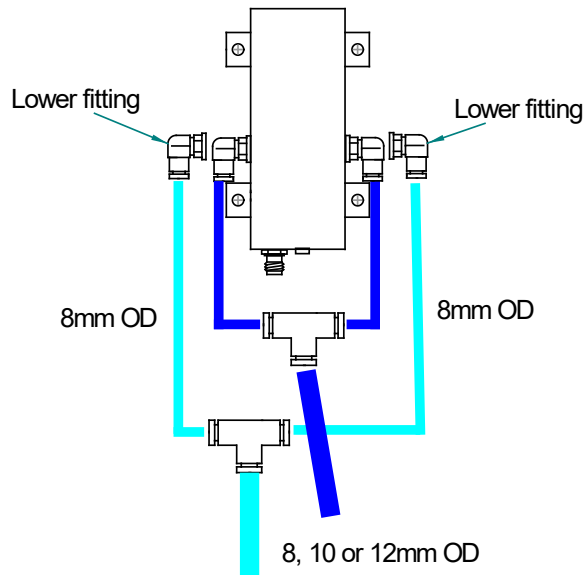
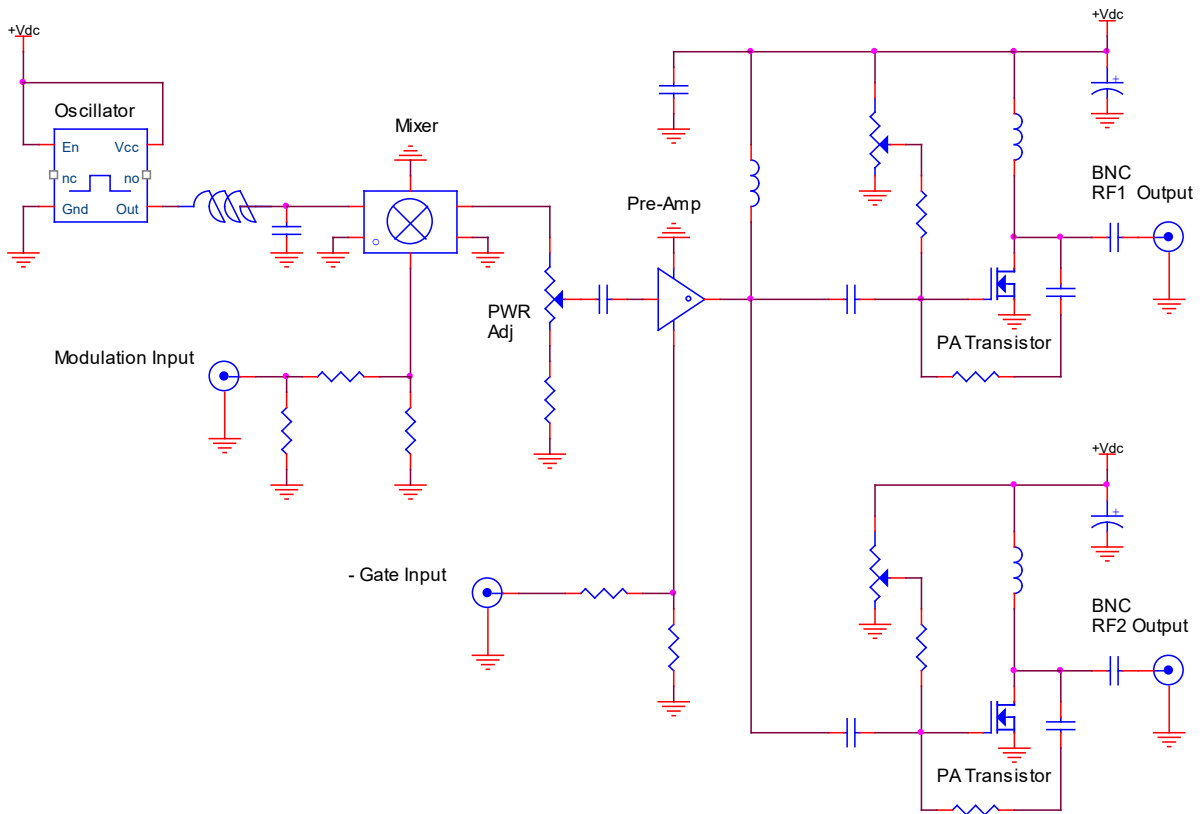

Figure 4: Driver Installation



Coolant flow

Flow rate enhancement using dual fittings and T-piece.

For simple connection, use an upper and lower water fitting on the left or right side,

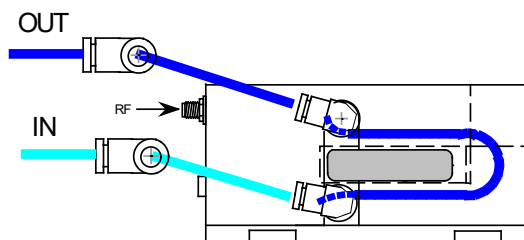
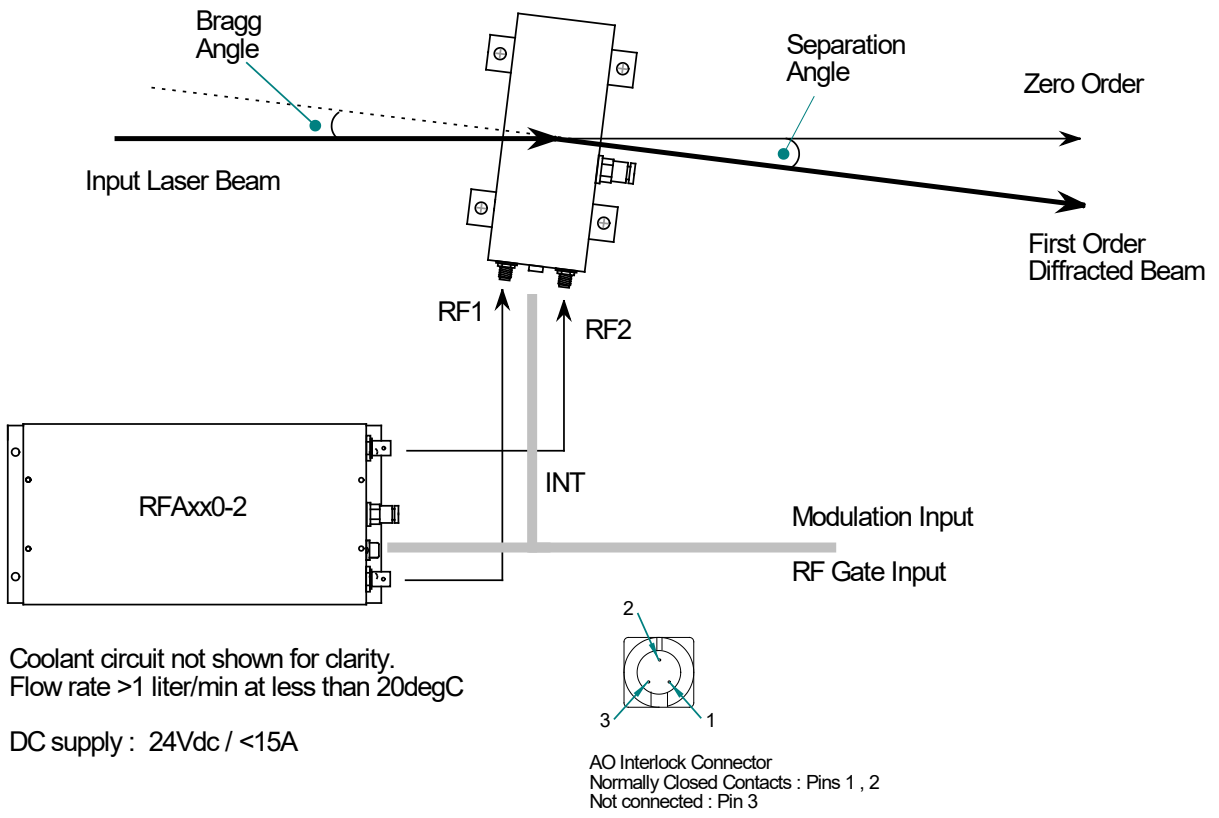

Figure 5: Driver Block Diagram & Coolant Schematics



Alternative Input Bragg Angle orientations:

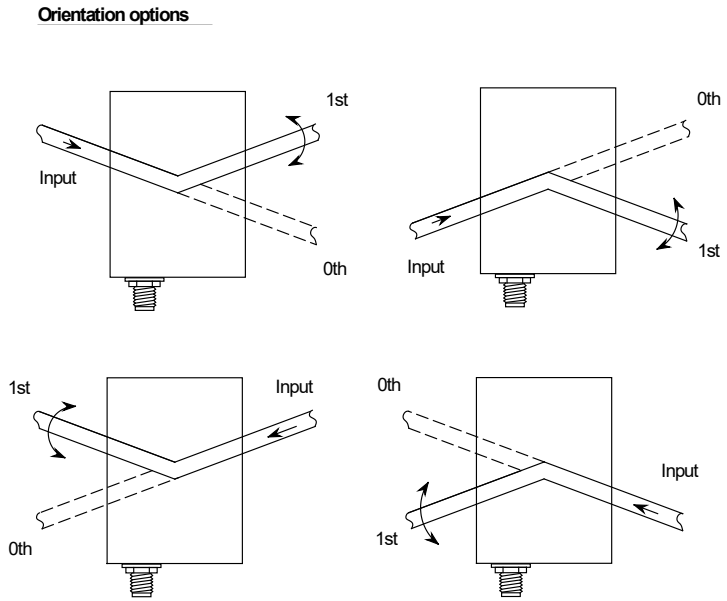
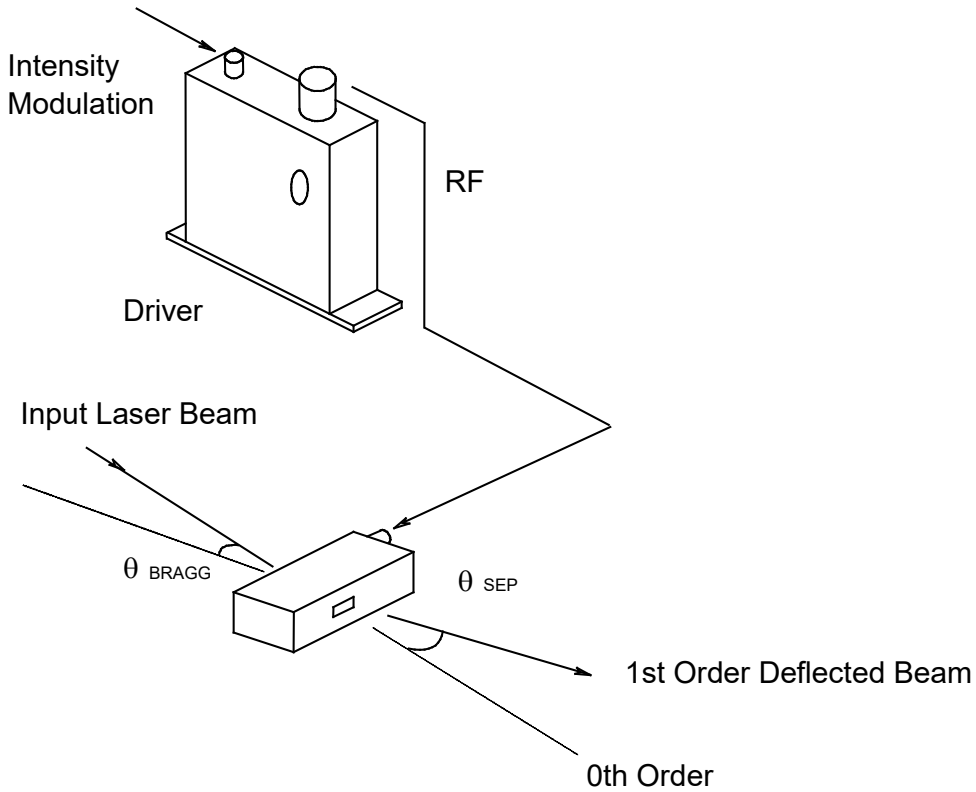

Figure 6: Typical Connection Configuration

Basic AO Modulator Parameters



The input Bragg angle, relative to a normal to the optical surface and in the plane of deflection is:

$$\theta_{BRAGG} = \frac{\lambda \cdot fc}{2 \cdot v}$$

The separation angle between the Zeroth order and the First order is:

$$\theta_{SEP} = \frac{\lambda \cdot fc}{v}$$

Optical rise time for a Gaussian input beam is approximately:

$$t_r = \frac{0.65 \cdot d}{v}$$

where:

λ = wavelength
 fc = centre frequency = 40MHz / RFA240-2, RFA440-2
 50MHz / RFA250-2, RFA450-2

v = acoustic velocity of interaction material = 5.5mm/usec (Ge)
 d = $1/e^2$ beam diameter

Figure 7. Modulation System

Appendix A: Beam Position

Timing Considerations for AO Devices in Pulsed Lasers Applications

When attempting to synchronize a pulsed laser beam with a pulsed RF acoustic wave in an AO device, the designer must consider the transit time of the acoustic wave from the transducer to the laser beam position. This is called the *Pedestal delay*.

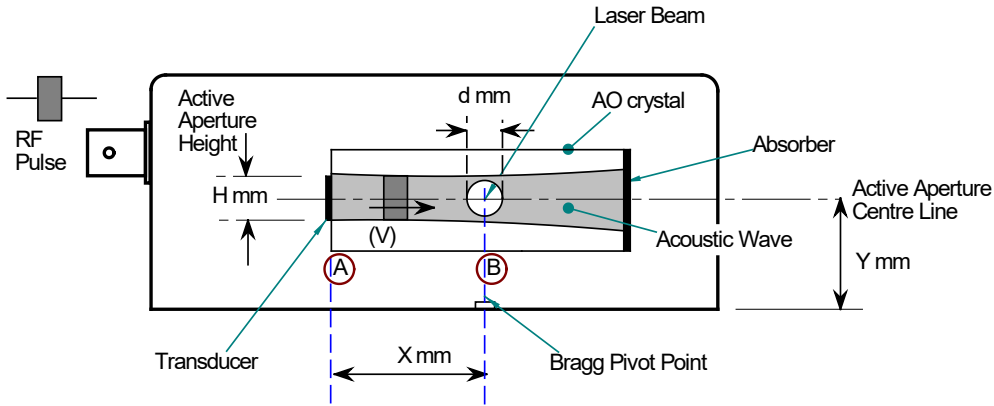

Input Beam Location

Vertical axis: Place the laser beam at the centre of the active aperture at Y mm above the base.
 Horizontal (Diffraction) axis: Place beam above the Bragg pivot point.

Timing considerations with respect to the RF modulation signal

An acousto-optic device is characterized by a travelling acoustic wave. This wave is launched from the RF excited transducer and travels at velocity V across the laser beam and into the absorber. It is important to consider this transit period when synchronizing a pulsed laser output with a pulsed AOM/AOD driver signal.

Early/late refers to the laser trigger timing relative to the RF driver modulation signal

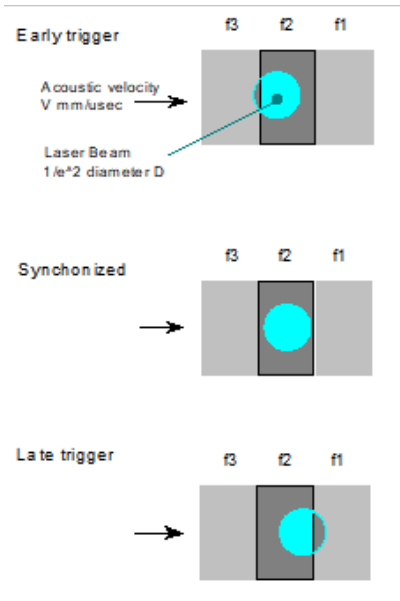

Pedestal delay

The time taken for the acoustic wavefront to reach the laser beam centre ⁽²⁾.

$T_p = \frac{\text{beam position from transducer (X)}}{\text{acoustic velocity (V)}}$

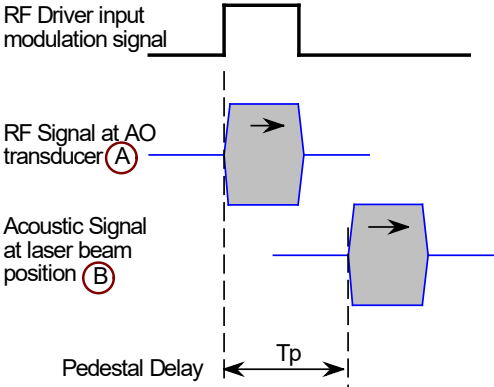

Transit time

The time taken for the acoustic wavefront to cross the entire laser beam diameter.

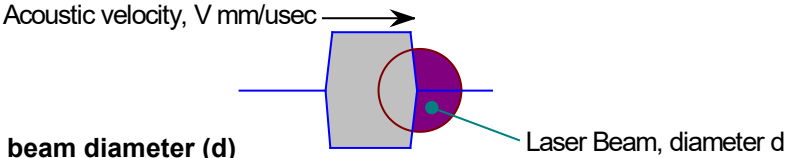

where: $T_t = \frac{\text{beam diameter (d)}}{\text{acoustic velocity (V)}}$

This equates to the minimum RF pulse width.

Optical rise / fall switching time

For a Gaussian beam is approximately $T_r = 0.65 \times T_t$

Total Sync Time

This represents the total delay time between the electronic modulation signal and the corresponding acoustic signal at the laser beam centred over the Bragg Pivot Point. This is given by :

$T_{st} = \text{Pedestal delay} + \frac{1}{2} \text{ pulse width duration}$

The minimum RF pulse width duration will depend on the beam diameter. See 'Transit Time' In the limiting case, pulse width duration = transit time.

Laser sync output

Please be aware, there may be an additional delay between the laser input trigger signal and the laser output pulse. This delay should also be considered when synchronizing.